

★★★★ villa  
mercede  
HOTEL&SPA

# NUOVOCENTROCONGRESSI

@ VillaMercede





★★★★ villa  
mercede  
HOTEL & SPA

## SALA CAMPITELLI

123 mq



Platea

90 PAX

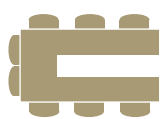

Ferro di Cavallo

35 PAX

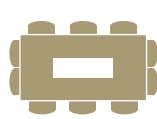

Tavolo Imperiale

35 PAX



Banchi di scuola

48 PAX



Banchetto

SECONDO  
ALLESTIMENTO

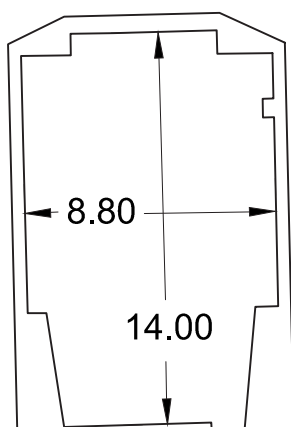

### Dotazione

- 3 microfoni fissi
- 1 microfono wi-fi gelato
- 1 microfono archetto
- Luce naturale
- Videoproiettore
- Flip chart
- Schermo in 16:9
- Collegamento HDMI e VGA
- Free Wi-Fi
- Aria condizionata
- Puntatore laser
- Logitech presenter professional
- Welcome desk (su richiesta)
- Radiomicrofono amplificato
- Notebook collegabile a video screen (su richiesta)



WWW.VILLAMERCEDE.COM

Via Tuscolana, 20 - 00044 Frascati (RM)

TEL: +39 069424760

FAX: +39 069416461

congressi@villamercede.com

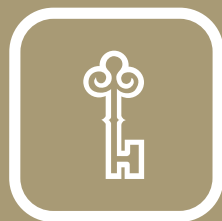

★★★★ villa  
mercede  
HOTEL & SPA

## SALA TUSCOLO

23 mq



Platea

12 PAX

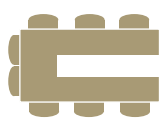

Ferro di Cavallo

ALLESTIMENTO  
NON DISPONIBILE

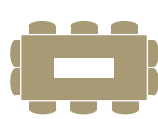

Tavolo Unico

12 PAX



Banchi di scuola

9 PAX



Banchetto

ALLESTIMENTO  
NON DISPONIBILE

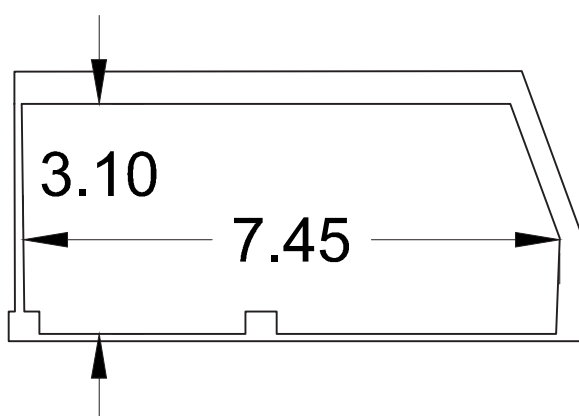

### Dotazione

- Schermo LCD
- Flip chart
- Luce naturale
- Aria condizionata
- Radiomicrofono amplificato
- Notebook collegabile a video screen (su richiesta)
- Welcome desk (su richiesta)
- Free WI-FI



WWW.VILLAMERCEDE.COM

Via Tuscolana, 20 - 00044 Frascati (RM)

TEL: +39 069424760

FAX: +39 069416461

congressi@villamercede.com



★★★★ villa  
mercede  
HOTEL&SPA

## SALA CHIGI

45 mq



Platea

40 PAX

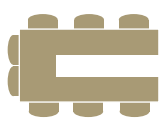

Ferro di Cavallo

15 PAX

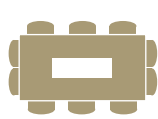

Tavolo Imperiale

18 PAX



Banchi di scuola

24 PAX



Banchetto

30 PAX

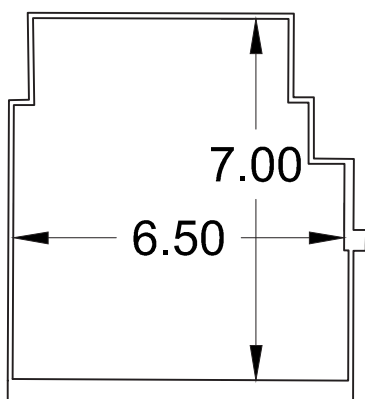

### Dotazione

- 1 microfono wi-fi gelato
- 1 microfono archetto
- Luce naturale
- Videoproiettore
- Flip chart
- Schermo in 16:9
- Collegamento HDMI e VGA
- Free Wi-Fi
- Aria condizionata
- Puntatore laser
- Logitech presenter professional
- Radiomicrofono amplificato
- Welcome desk (su richiesta)
- Notebook collegabile a video screen (su richiesta)



WWW.VILLAMERCEDE.COM

Via Tuscolana, 20 - 00044 Frascati (RM)

TEL: +39 069424760

FAX: +39 069416461

congressi@villamercede.com





★★★★ villa  
mercede  
HOTEL&SPA

## SALA TORLONIA

19 mq



Platea

8 PAX

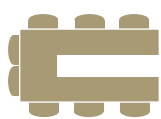

Ferro di Cavallo

ALLESTIMENTO  
NON DISPONIBILE

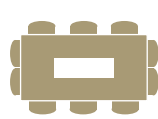

Tavolo Imperiale

12 PAX



Banchi di scuola

ALLESTIMENTO  
NON DISPONIBILE

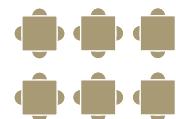

Banchetto

ALLESTIMENTO  
NON DISPONIBILE

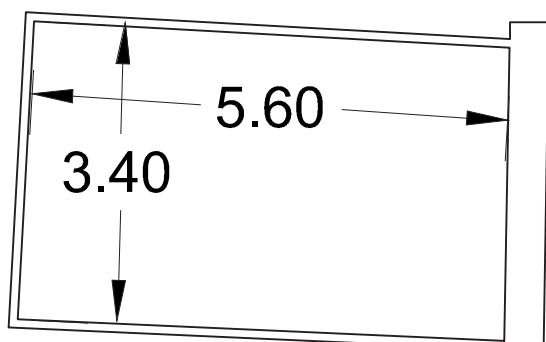

### Dotazione

- Schermo LCD
- Flip chart
- Luce naturale
- Aria condizionata
- Radiomicrofono amplificato
- Notebook collegabile a video screen (su richiesta)
- Welcome desk (su richiesta)
- Free WI-FI



WWW.VILLAMERCEDE.COM

Via Tuscolana, 20 - 00044 Frascati (RM)

TEL: +39 069424760

FAX: +39 069416461

congressi@villamercede.com

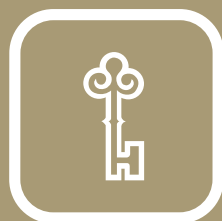

★★★★ villa  
mercede  
HOTEL&SPA

## TARIFFE MEETING

	FULL DAY	1/2 DAY
SALA CAMPITELLI	€ 450.00	€ 350.00
SALA CHIGI	€ 300.00	€ 220.00
SALA TUSCOLO	€ 190.00	€ 150.00
SALA TORLONIA	€ 90.00	€ 70.00

+Iva 22%

### SERVIZI AGGIUNTIVI

Servizio fax	€ 0,50/pg
Servizio fotocopie	€ 0,10/pg
Servizio copie a colori	€ 0,20/pg
Hostess in sala 1/2 day	€ 80,00
Hostess in sala full day	€ 100,00
Personale assistenza tecnica	€ 100,00
Secretariat office	€ 100,00

compresa Iva



[WWW.VILLAMERCEDE.COM](http://WWW.VILLAMERCEDE.COM)

Via Tuscolana, 20 - 00044 Frascati (RM)

TEL: +39 069424760

FAX: +39 069416461

[congressi@villamercede.com](mailto:congressi@villamercede.com)



★★★★ villa  
mercede  
HOTEL&SPA

---

## TARIFFE CATERING

---

### COFFEE BREAK da € 10,00

BEVERAGE: Coffee, infusi, latte, succhi di frutta, acqua minerale.  
FOOD: mini croissants, mini tramezzini, chips, rustici, pasticceria secca fatta in casa, frutta di stagione.  
LOCATION: Hall albergo - Foyer Campitelli - Lounge Bar - Piscina - Garden

---

### COFFEE BREAK O APERITIVO RINFORZATO da € 15,00

BEVERAGE: Coffee, infusi, latte, succhi di frutta, acqua minerale.  
FOOD: mini croissants, mini tramezzini, chips, rustici, frittini, torte rustiche, pasticceria secca fatta in casa, frutta di stagione.  
LOCATION: Hall albergo - Foyer Campitelli - Lounge Bar - Piscina - Garden

---

### LUNCH BUFFET da € 18,00 (incluse bevande)

Ricco assortimento di pietanze fredde e calde, primi, secondi, verdure e buffet di dolci  
LOCATION: Sala view del ristorante

---

### PRANZO DI LAVORO da € 35,00

3 portate, inclusi 1/2 lt di acqua minerale e 1/4 lt di vino DOCG Frascati  
LOCATION: Sala view del ristorante - Garden

---

### WORKING DINNER da € 35,00

3 portate, inclusi 1/2 lt di acqua minerale e 1/4 lt di vino DOCG Frascati  
LOCATION: Sala view del ristorante - Garden

---

### GALA MENU

LOCATION: Sala view del ristorante - Bordo Piscina  
(Con quotazione da personalizzare)

---

Prezzi Iva Inclusa



WWW.VILLAMERCEDE.COM

Via Tuscolana, 20 - 00044 Frascati (RM)

TEL: +39 069424760

FAX: +39 069416461

congressi@villamercede.com